

IMPORTANT SAFEGUARDS

PLEASE FIND A QUALIFIED ELECTRICIAN FOR INSTALLATION. Please read the instructions carefully before installing and using the luminaire

WARNING, CAUTIONS AND OPERATING INSTRUCTIONS

- To mitigate the risk of fire, electric shock, injury from falling parts, cuts, abrasions, and other hazards, please thoroughly read all warnings and instructions provided with the fixture, including those on the fixture box and labeling.
- Prior to installation, servicing, or routine maintenance of this luminaire, adhere to the general safety precautions.
- Commercial installation, servicing, and maintenance of luminaires should only be carried out by a qualified, licensed electrician.
- If you have any doubts about installing or maintaining the luminaires, it's advisable to consult a qualified, licensed electrician and verify your local electrical code.
- To avoid damage or abrasion to wiring, ensure that wiring is not exposed to the edges of sheet metal or other sharp objects.
- Refrain from creating or altering any open holes in an enclosure that contains wiring or electrical components during the installation of the kit.

WARNING: RISK OF FIRE OR ELECTRICAL SHOCK

- Ensure electrical power is turned off at the fuse or circuit breaker box before connecting the fixture to the power supply.
- Always turn off the power before performing any maintenance.
- Confirm that the supply voltage matches the luminaire label information.
- Complete all electrical and grounding connections in compliance with the National Electrical Code and any relevant local code requirements.
- Use UL approved wire connectors for all wiring connections.

CAUTION: RISK OF INJURY

- Avoid looking directly at the light source when it is on.
- Properly dispose of small parts and packing materials to keep children safe.
- The green ground screw is pre-installed in the correct location. It should not be relocated.
- Ensure the use of minimum 90° supply conductors.
- This product is suitable for use in Dry or Damp locations.

INSTALLATION AND ELECTRICAL CONNECTION:

SUSPENSION CABLE

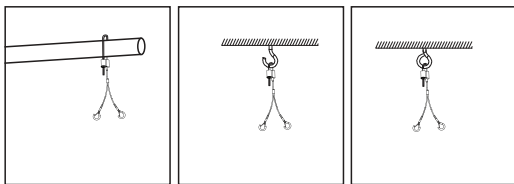

1. Hang the suspension rope through the ring, hook or rod.

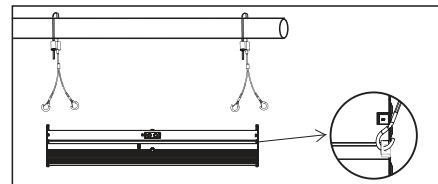

2. Hook the spring buckle on the suspension rope to the installation hole of the fixture, as shown in the picture above

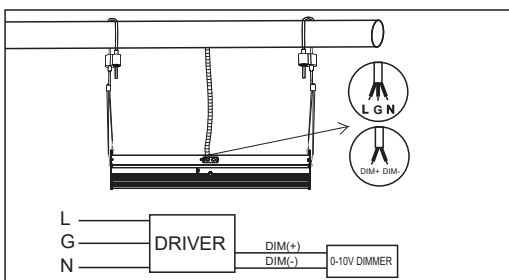

3. Please connect all cables and terminals according to the wiring diagram (also stated on the driver). Please make sure Ground wire is connected properly.

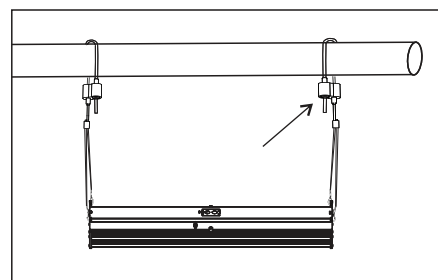

4. Adjust the suspension rope to maintain steady fixture height.

GENERAL WIRING DIAGRAM

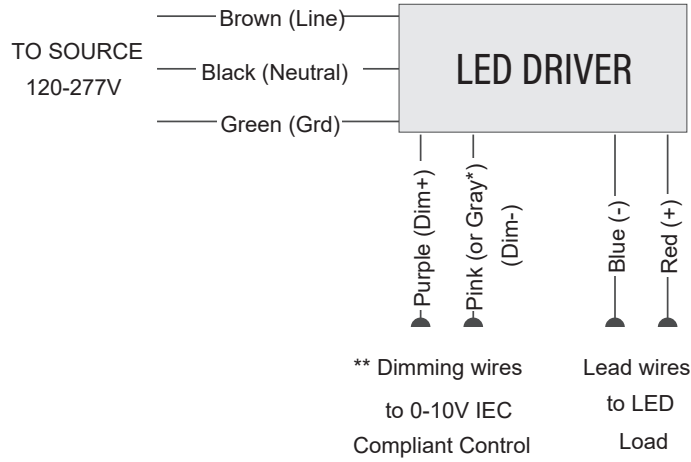

INSTALLATION OF SENSOR

Fig 1

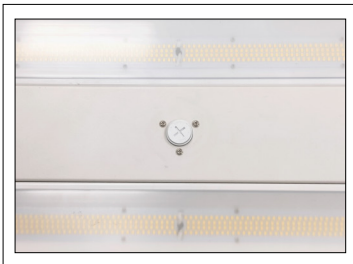

1) Switch off the power.

Fig 2

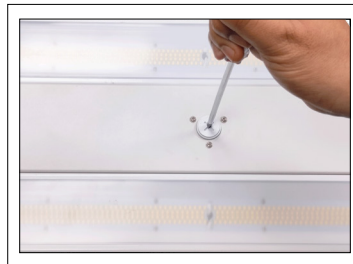

2) Use a screwdriver to remove the cap, creating an opening for the sensor insertion.

Fig 3



3) Insert the sensor into the fixture through the created opening, using the Aux pin.

Fig 4

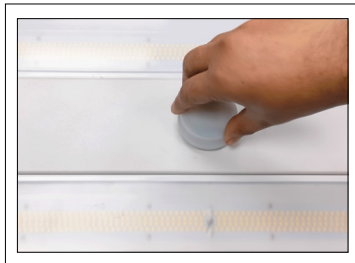

4) Once the sensor is in place, rotate it clockwise to secure it firmly.

Fig 5

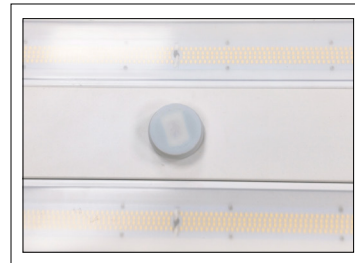

5) Your fixture is ready to use with the sensor. Now, turn on the power. If there are any issues, please contact our representative.