

ITEM SKU#: 662187461649

Dynamo 3

Stadium Flood Light

INDUSTRIAL LIGHTING | FLOOD LIGHTS



FEATURES

- Superior aesthetics with a modern look.
- Excellent heat management system courtesy of multiple vents.
- 240° adjustable angle.
- Multi-faceted optic design to distribute light evenly and reduce glare.
- Resistant to electrical interference due to high quality chip.

APPLICATIONS

Stadiums, Sports Fields, High Mast Lighting, Light Towers, or Ports.

PRODUCT DETAILS

ELECTRICAL

Power	495.6 W
Voltage	100-277 V
Current	1.88 A
Power Factor	0.952
Total Harmonic Distortion (THD)	9.9%
Surge Protection	10 kV

LIGHTING PERFORMANCE

Lumens	75028.1 lm
Efficacy	151.4 lm/W
Color Temperature (CCT)	3500 K
Color Rendering (CRI)	73.5
R9 (Red Value)	-23
R13 (Skin Tones)	73
Beam Angle	30°
Light Distribution	Type I, Very Short
BUG Rating (Backlight, Uplight, and Glare)	B5-U3-G2
Dimmable Lighting Control	Continuous Dimming to 10% or Below

ENVIRONMENT

Operating Temperature	-22 °F ~ +122 °F
Suitable Location	WET
Ingress Protection Rating (IP)	IP66
Impact Protection Rating (IK)	IK08

LIFESPAN

Average Life (Hours)	100,000
Warranty (Years)	10

COMPONENTS

LED Light Source	LUMILEDS
Driver	INVENTRONICS

CONSTRUCTION

Housing	Die-cast aluminum
Cover Material / Lens	PC
Diffuser	Clear
Base / Power Supply	Hard Wire
Finish	Black
Effective Projected Area (EPA)	1.59 ft²
Wind Shear Rating	127.5 mph

PART NUMBER & QUALIFICATIONS

Ordering Part Number	IK-SLEL2-0500-D-35 (30D)
Qualified Part Number	IK-SLEL2-0500-D-35
SKU Number	662187461649



Not all product variations listed on this page are DLC qualified. Visit <https://www.designlights.org/qpl> to confirm qualification.

Note: *Fixtures mustn't be mounted facing upwards; it won't be covered under warranty.

DIMENSIONS AND WEIGHT

Width (Inches)	16.33"
Height (Inches)	19.65"
Diameter (Inches)	15.94"
Net Weight (lbs)	27.55

PACKAGING

Box Dimensions (Inches)	17.71" x 17.71" x 13.97"
Box Weight (lbs)	31.96
Quantity Per Box	1

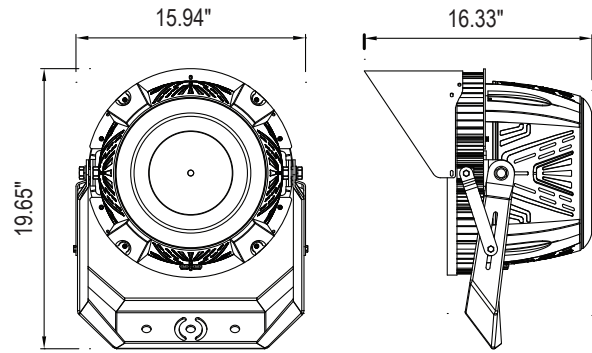

SUPPORTING DOCUMENTS

DOCUMENTS	DOCUMENT LINK
Product Sheet	View / Download
IES Files	View / Download
LM79 Report	View / Download
LM80 Report	View / Download
Installation Instructions	View / Download

ORDERING INFORMATION

SKU NUMBER	DESCRIPTION	QUANTITY/BOX
662187461649	DYNAMO 3 SFL : 495.6 W / 75028.1 LM / 3500 K / 100-277 V / BLACK / DLC	1

ACCESSORIES

INCLUDED IN THE BOX

SKU NUMBER	PRODUCT CODE	DESCRIPTION	DOCUMENT LINK
662187477060	IK-ACC-SHIELD	SHIELD	View / Download
662187477213	IK-ACC-YKMT	YOKE MOUNT KIT	View / Download

SOLD SEPARATELY

SKU NUMBER	PRODUCT CODE	DESCRIPTION	DOCUMENT LINK
662187477190	IK-ACC-SFMB	SLIP FITTER MOUNTING BRACKET	View / Download
662187478821	IK-ACC-LAD	LASER AIMING DEVICE	View / Download
662187479576	IK-ACC- CNV-SNAP-ANO	SYNAPSE- WIRELESS CONTROL SYSTEM	View / Download