

ITEM SKU#: 662187480091

Dynamo 3 Pro Stadium Flood Light

INDUSTRIAL LIGHTING | STADIUM FLOOD LIGHTS



FEATURES

- Excellent heat management system.
- Cold forging aluminum housing with anti-corrosion polyester powder coated finish.
- High energy savings as compared to traditional stadium lights.
- Special circuit design for each part to work separately.
- Adjustable output current (AOC) with NFC.

APPLICATIONS

Sports Facilities, Stadiums, Container Loading Areas, Shipping Yards, Airports, Ports

PRODUCT DETAILS

ELECTRICAL

Power	750 W
Voltage	277-480 V
Current	--
Power Factor	0.95
Total Harmonic Distortion (THD)	<15%
Surge Protection	10/20 kV Optional

LIGHTING PERFORMANCE

Lumens	120000 lm
Efficacy	160 lm/W
Color Temperature (CCT)	5000 K
Color Rendering (CRI)	90
R9 (Red Value)	--
R13 (Skin Tones)	--
Beam Angle	30°
Light Distribution	--
BUG Rating (Backlight, Uplight, and Glare)	--
Dimmable Lighting Control	--

ENVIRONMENT

Operating Temperature	-40 °F ~ +122 °F
Suitable Location	WET
Ingress Protection Rating (IP)	IP66
Impact Protection Rating (IK)	IK09

LIFESPAN

Average Life (Hours)	100,000
Warranty (Years)	10

COMPONENTS

LED Light Source	Luxeon 5050
Driver	Inventronics/Meanwell

CONSTRUCTION

Housing	Cold Forging Aluminum
Lens	Anti-UV PC Optical Material
Base / Power Supply	--
Finish	Black
Effective Projected Area (EPA)	1.40 ft ²
Wind Shear Rating	--

QUALIFICATIONS

Model Number	Not Qualified Yet
SKU Number	662187480091



DIMENSIONS AND WEIGHT

Height (With Bracket)	22.4"
Diameter	Ø18.2"
Width	14.9"
Net Weight (lbs)	33.06

PACKAGING

Box Dimensions (Inches)	25.4" x 21.5" x 15.0"
Box Weight (lbs)	44.09
Quantity Per Box	--

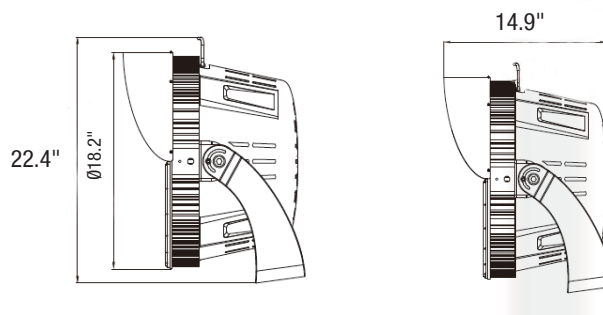

SUPPORTING DOCUMENTS

Product Sheet	View / Download
Installation Instructions	View / Download
IES Files	On Request
LM79 Files	On Request
LM80 Files	On Request

ORDERING INFORMATION

ITEM	DESCRIPTION	CASE
662187480091	DYNAMO 3 PRO STADIUM FLOOD LIGHT: 750 W / 5000 K / 277-480 V	1