

ITEM SKU#: 662187539560

LOCUS Area Luminaire

INDUSTRIAL LIGHTING | AREA LUMINAIRES



FEATURES

- Compact, low-profile design delivers high-performance illumination and improves application site aesthetics.
- Heavy-duty, die-cast aluminum housing with an efficient heat sink for enhanced heat dissipation.
- Designed for Dark Sky compliant performance, eliminating undesirable sky glow.
- Easy 1 person installation with our quick mount bracket and hinged door frame; installer can be hands free when establishing electrical connections.

APPLICATIONS

Outdoor Illumination Needs, Including Parking Lots, Auto Dealerships, Pathways, Roadways, Recreational Venues, and Other General Area Lighting; Can Also be Used as Flood Lights.

MOUNTING OPTIONS

- Pole Mount
- Wall Mount

PRODUCT DETAILS

ELECTRICAL

Power	94.2 W
Voltage	100-277 V
Current	0.35 A
Power Factor	0.964
Total Harmonic Distortion (THD)	6.6%
Surge Protection	6 kV

LIGHTING PERFORMANCE

Lumens	13323 lm
Efficacy	141.44 lm/W
Color Temperature (CCT)	3000 K
Color Rendering (CRI)	73
R9 (Red Value)	-22
R13 (Skin Tones)	73
Beam Angle	137.9°
Light Distribution	T3
BUG Rating (Backlight, Uplight, and Glare)	B3-U1-G2
Dimmable Lighting Control	Continuous Dimming to 10% or Below

ENVIRONMENT

Operating Temperature	-40 °F ~ +131 °F
Suitable Location	WET
Ingress Protection Rating (IP)	IP66
Impact Protection Rating (IK)	IK10

LIFESPAN

Average Life (Hours)	100,000
Warranty (Years)	10

COMPONENTS

LED Light Source	Bridgelux
Driver	Inventronics

CONSTRUCTION

Housing	Aluminum
Cover Material / Lens	Polycarbonate
Base / Power Supply	Hard Wired / Surge Protector
Finish	White
Effective Projected Area (EPA)	0.23 ft²
Wind Shear Rating	117 mph

PART NUMBER & QUALIFICATIONS

Ordering Part Number	IK-SBSL1-0100-30-DY-RLV01[Blank, -AI] (White T3)
Qualified Part Number	IK-SBSL1-0100-30-DY-RLV01[Blank, -AI]
SKU Number	662187539560



Not all product variations listed on this page are DLC qualified. Visit <https://www.designlights.org/qpl> to confirm qualification.

DIMENSIONS AND WEIGHT

Length (Inches)	14.56"
Width (Inches)	12.20"
Height (Inches)	4.17"
Net Weight (lbs)	8.81

PACKAGING

Box Dimensions (Inches)	18.00" x 14.00" x 6.00"
Box Weight (lbs)	10.73
Quantity Per Box	1

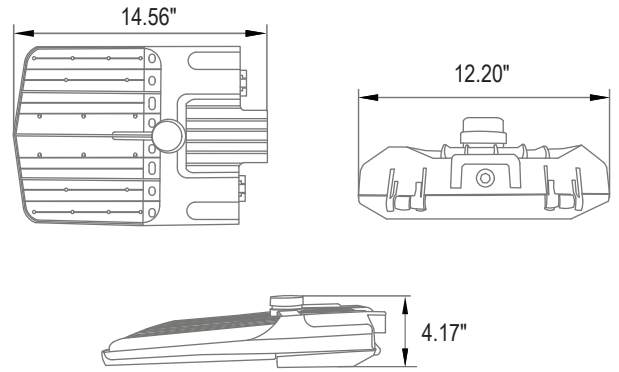

SUPPORTING DOCUMENTS

DOCUMENTS	DOCUMENT LINK
Product Sheet	View / Download
IES Files	View / Download
LM79 Report	View / Download
LM80 Report	View / Download
Installation Instructions	View / Download

ORDERING INFORMATION

SKU NUMBER	DESCRIPTION	QUANTITY/BOX
662187539560	LOCUS AREA LUMINAIRE : 94.2 W / 13323 LM / 3000 K / 100-277 V / WHITE	1

ACCESSORIES

SOLD SEPARATELY

SKU NUMBER	PRODUCT CODE	DESCRIPTION	DOCUMENT LINK
662187560120	IK-SBSL/2-S4C-90-480V	Shorting Cap	View / Download
662187560021	IK-SBSL/2-PHC-90-277V	Photocell 90-277 V	View / Download
662187560106	IK-SBSL/2-PHC-200-480V	Photocell 200-480 V	View / Download
662187477657	S618-P-DR : PIR Sensor	PIR Sensor with 0–10 V Dimming	View / Download
662187549934	IK-SBSL1-SF-A (White)	Mounting Bracket: A - Slip Fitter (White)	View / Download
662187549965	IK-SBSL1-SP-B (White)	Mounting Bracket: B - Square & Round (White)	View / Download
662187549996	IK-SBSL1-TR-C (White)	Mounting Bracket: C - Trunnion (White)	View / Download
662187481999	IK-SBSL1-SP-B-(Spacer) White	Spacer (White)	-

*Choice of one accessory: Mounting Bracket (Slip Fitter, Square & Round with Spacer, Trunnion Mount), Shorting Cap or Photocell (either one) is included with the order. Contact your IKIO sales representative to buy replacement/additional Mounting Bracket.

*Product requires top-mounted shorting cap or optional twist-lock photocell installed to operate.