

ITEM SKU#: 662187539683

T8 Tube Type B (4')

COMMERCIAL LIGHTING | LED TUBES



FEATURES

- Can run directly off the main switch without any major rewiring.
- Unique design with a perfectly uniform visual appearance.
- Exceptional efficacy and light output with a wide beam angle and no flickering.
- Low energy consumption and maintenance cost.
- In-built universal line voltage driver options.
- Ideal for operation in low temperatures.

APPLICATIONS

Offices, Schools, Retail Stores, General Areas,
Residential Spaces, Lobbies

PRODUCT DETAILS

ELECTRICAL

Power	18 W
Voltage	100-277 V
Current	0.07 A
Power Factor	0.904
Total Harmonic Distortion (THD)	24.5%

LIGHTING PERFORMANCE

Lumens	2835 lm
Efficacy	157.85 lm/W
Color Temperature (CCT)	4500 K
Color Rendering (CRI)	81
R9 (Red Value)	2
R13 (Skin Tones)	81
Beam Angle	143°
Light Distribution	Type I, Very Short
Dimmable Lighting Control	Continuous Dimming to 10% or below

* Controller required. (Ordered Separately)

ENVIRONMENT

Operating Temperature	-4 °F ~ +104 °F
Suitable Location	DAMP
Ingress Protection Rating (IP)	IP20
Suitable Fixture Type	Existing T8 Fixture with G13 Socket

LIFESPAN

Average Life (Hours)	50,000
Warranty (Years)	5

COMPONENTS

LED Light Source	Runlite SMD 2835
Driver	Internal Driver / Line Voltage

CONSTRUCTION

Housing	Aluminum
Cover Material / Lens	Polycarbonate
Diffuser	Frosted
Base / Power Supply	G13, Single/Double Ended Power Input
Finish	White

PART NUMBER & QUALIFICATIONS

Ordering Part Number	IK-T804-0018-45B-SF (Frosted)
Qualified Part Number	IK-T804-0018-45B-SF
SKU Number	662187539683



Not all product variations listed on this page are DLC qualified. Visit <https://www.designlights.org/qpl> to confirm qualification.

DIMENSIONS AND WEIGHT

Length (Inches)	47.71"
Diameter (Inches)	1.26"
Net Weight (lbs)	0.48

PACKAGING

Box Dimensions (Inches)	49.60" x 14.17" x 9.05"
Box Weight (lbs)	27.55
Quantity Per Box	25

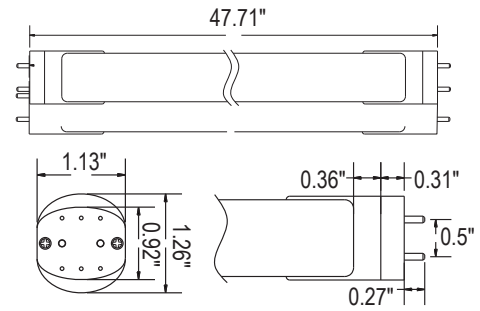

SUPPORTING DOCUMENTS

DOCUMENTS	DOCUMENT LINK
Product Sheet	View / Download
IES Files	View / Download
LM79 Report	View / Download
LM80 Report	View / Download
Installation Instructions	View / Download

ORDERING INFORMATION

SKU NUMBER	DESCRIPTION	QUANTITY/BOX
662187539683	T8 TUBE TYPE B : 4FT / 18 W / 2835 LM / 4500 K / 100-277 V / WHITE	25

BASIC WIRING DIAGRAM:

SINGLE ENDED POWER INPUT

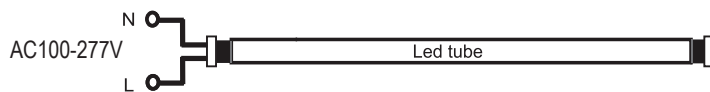

DOUBLE ENDED POWER INPUT

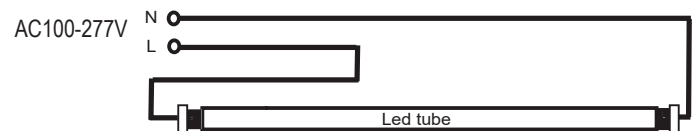

ADDITIONAL INFORMATION:

- In direct wire application, shunted sockets use double ended wiring only and non-shunted can use either single or double ended wiring. Please refer to installation instructions for further details.
- IKIO Direct-Wire (UL Type B) Lamps are designed for use with LED-Ready fixtures (follow lamp wiring instructions). When using any alternate-brand fixture, please review the specific IKIO lamp installation guide wiring requirements first to make sure the fixture is compatible before lamp installation.