

ITEM SKU#: 662187477688

# T8 Tube Type B (4')

COMMERCIAL LIGHTING | LED TUBES



## FEATURES

- Can run directly off the main switch without any major rewiring.
- Unique design with a perfectly uniform visual appearance.
- Exceptional efficacy and light output with a wide beam angle and no flickering.
- Low energy consumption and maintenance cost.
- In-built universal line voltage driver options.
- Ideal for operation in low temperatures.

## APPLICATIONS

Offices, Schools, Retail Stores, General Areas,  
Residential Spaces, Lobbies

## PRODUCT DETAILS

### ELECTRICAL

Power	12.1 W
Voltage	100-277 V
Current	0.05 A
Power Factor	0.906
Total Harmonic Distortion (THD)	24.8%

### LIGHTING PERFORMANCE

Lumens	1844 lm
Efficacy	152.52 lm/W
Color Temperature (CCT)	5000 K
Color Rendering (CRI)	81
R9 (Red Value)	2
R13 (Skin Tones)	83
Beam Angle	142°
Light Distribution	Type I, Very Short
Dimmable Lighting Control	Continuous Dimming to 10% or below

\* Controller required. (Ordered Separately)

### ENVIRONMENT

Operating Temperature	-4 °F ~ +104 °F
Suitable Location	<b>DAMP</b>
Ingress Protection Rating (IP)	IP20
Suitable Fixture Type	Existing T8 Fixture with G13 Socket

### LIFESPAN

Average Life (Hours)	50,000
Warranty (Years)	<b>5</b>

### COMPONENTS

LED Light Source	Runlite SMD 2835
Driver	Internal Driver / Line Voltage

### CONSTRUCTION

Housing	Aluminum
Cover Material / Lens	Polycarbonate
Diffuser	Frosted
Base / Power Supply	G13, Single/Double Ended Power Input
Finish	White

### PART NUMBER & QUALIFICATIONS

Ordering Part Number	IK-T804-0012-50B-SF (Frosted)
Qualified Part Number	IK-T804-0012-50B-SF
SKU Number	662187477688



Not all product variations listed on this page are DLC qualified. Visit <https://www.designlights.org/qpl> to confirm qualification.

**DIMENSIONS AND WEIGHT**

<b>Length</b> (Inches)	47.71"
<b>Diameter</b> (Inches)	1.26"
<b>Net Weight</b> (lbs)	0.48

**PACKAGING**

<b>Box Dimensions</b> (Inches)	49.60" x 14.17" x 9.05"
<b>Box Weight</b> (lbs)	27.55
<b>Quantity Per Box</b>	25

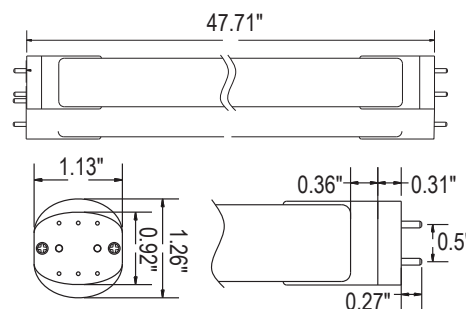

**SUPPORTING DOCUMENTS**

DOCUMENTS	DOCUMENT LINK
<a href="#">Product Sheet</a>	<a href="#">View / Download</a>
<a href="#">IES Files</a>	<a href="#">View / Download</a>
<a href="#">LM79 Report</a>	<a href="#">View / Download</a>
<a href="#">LM80 Report</a>	<a href="#">View / Download</a>
<a href="#">Installation Instructions</a>	<a href="#">View / Download</a>

**ORDERING INFORMATION**

SKU NUMBER	DESCRIPTION	QUANTITY/BOX
662187477688	T8 TUBE TYPE B : 4FT / 12.1 W / 1844 LM / 5000 K / 100-277 V / WHITE	25

**BASIC WIRING DIAGRAM:**

SINGLE ENDED POWER INPUT

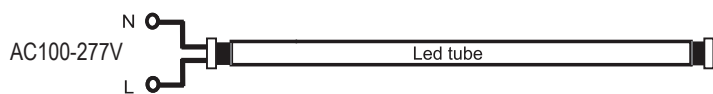

DOUBLE ENDED POWER INPUT

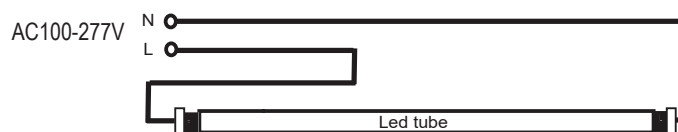

**ADDITIONAL INFORMATION:**

- In direct wire application, shunted sockets use double ended wiring only and non-shunted can use either single or double ended wiring. Please refer to installation instructions for further details.
- IKIO Direct-Wire (UL Type B) Lamps are designed for use with LED-Ready fixtures (follow lamp wiring instructions). When using any alternate-brand fixture, please review the specific IKIO lamp installation guide wiring requirements first to make sure the fixture is compatible before lamp installation.