

ITEM SKU#: 662187465272

T8 Tube Type A&B (4')

COMMERCIAL LIGHTING | LED TUBES



FEATURES

- Compatible with existing ballasts or can also be wired directly to the mains to run on line voltage; supports both single-ended and double-ended configurations.
- Designed for high efficacy, it delivers uniform and flicker-free lighting, reducing both energy and maintenance costs.
- Made of selectively sourced, premium components, the tube ensures durability and lasting performance.
- Easy to install and replace, making it perfect for the retrofitting of existing traditional tubes.
- Suitable for use in both dry and damp locations.

APPLICATIONS

Offices, Schools, Hospitals, Retail Stores, Lobbies, General Areas, Residential Spaces

PRODUCT DETAILS

ELECTRICAL

Power	20 W
Voltage	100-277 V
Current	0.08 A
Power Factor	0.9
Total Harmonic Distortion (THD)	15%
Surge Protection	5 kV

LIGHTING PERFORMANCE

Lumens	3000 lm
Efficacy	150 lm/W
Color Temperature (CCT)	5000 K
Color Rendering (CRI)	82
R9 (Red Value)	4
Beam Angle	151°
Light Distribution	Type I, Very Short
Dimmable Lighting Control	Continuous Dimming to 10% or Below

ENVIRONMENT

Operating Temperature	-4 °F ~ +104 °F
Suitable Location	DAMP
Ingress Protection Rating (IP)	IP20

LIFESPAN

Average Life (Hours)	50,000
Warranty (Years)	5

COMPONENTS

LED Light Source	SMD2835
Driver	Dual Mode Internal Driver (UL Type A and Type B), Single / Double Ended

CONSTRUCTION

Housing	Aluminum
Cover Material / Lens	Polycarbonate
Diffuser	Clear
Base	G13
Finish	White

PART NUMBER & QUALIFICATIONS

Ordering Part Number	IK-T804-0018-50A&B-SC (Clear)
Qualified Part Number	IK-T804-0018-50A&B-SC
SKU Number	662187465272



Not all product variations listed on this page are DLC qualified. Visit <https://www.designlights.org/apl> to confirm qualification.

DIMENSIONS AND WEIGHT

Length (Inches)	47.1"
Diameter (Inches)	1.18"
Net Weight (lbs)	0.48

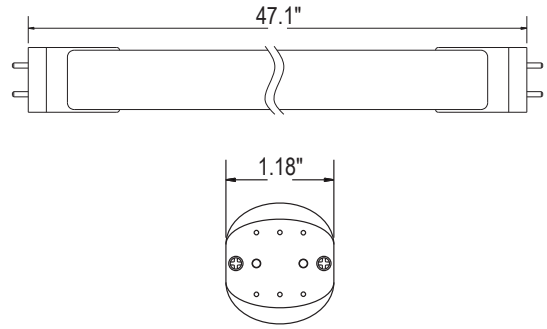

PACKAGING

Box Dimensions (Inches)	49.60" x 8.66" x 8.66"
Box Weight (lbs)	17.63
Quantity Per Box	25

SUPPORTING DOCUMENTS

DOCUMENTS	DOCUMENT LINK
Product Sheet	View / Download
IES Files	View / Download
LM79 Report	View / Download
LM80 Report	View / Download
Installation Instructions	View / Download

ORDERING INFORMATION

SKU NUMBER	DESCRIPTION	QUANTITY/BOX
662187465272	T8 TUBE TYPE A&B: 4FT / 20 W / 3000 LM / 5000 K / 100-277 V / WHITE	25

BASIC WIRING DIAGRAM:

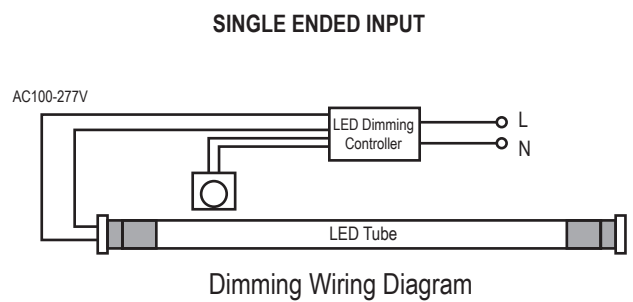
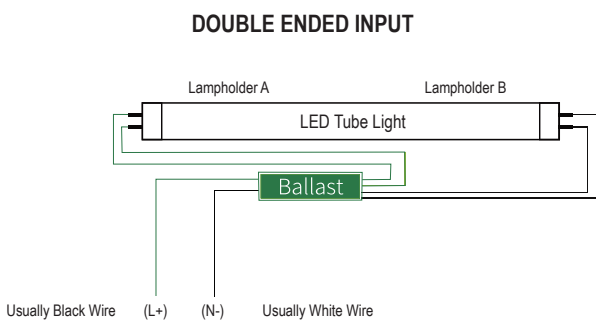

ADDITIONAL INFORMATION:

- In direct wire application, shunted sockets use double ended wiring only and non-shunted sockets can use either single or double ended wiring. Please refer to the installation instructions for further details.
- IKIO Direct-Wire (UL Type A&B) Lamps are designed for use with LED-Ready fixtures (follow lamp wiring instructions). When using any alternate-brand fixture, please review the specific IKIO lamp installation guide wiring requirements first to make sure the fixture is compatible before lamp installation.